

*Presented at the FIG Working Week 2016,
May 2-6, 2016 in Christchurch, New Zealand*

3D Data Fusion for 3D Modeling Applications for the Energy Sector

Anders NESSE, Ulf Hägnefelt (Norconsult)



FIG Working Week 2016

CHRISTCHURCH, NEW ZEALAND 2-6 MAY 2016

Recovery

from disaster

Organised by



Platinum Partners



Diamond Partner





Why should surveyors focus on the Energy Sector?

- an extremely **wide range** of applications
- utilization of **all kinds** of data capture and modeling methods
- 3D and **BIM** models required for all engineering disciplines
- **Surveying engineers** can contribute throughout the entire life cycle of any project
 - initial documentation
 - progress monitoring
 - project handover



FIG Working Week 2016

CHRISTCHURCH, NEW ZEALAND 2-6 MAY 2016

Recovery

from disaster

3D Data Acquisition



Platinum Partners:



Diamond Partner





FIG Working Week 2016

CHRISTCHURCH, NEW ZEALAND 2-6 MAY 2016

Recovery

from disaster

Data Processing – Project deliverables

- 3D CAD Models
- 3D BIM Models
- Elevation Views, Sections , Plan Views - Relational Drawings
- Terrain Modelling
- 3D collaboration models
- 3D visualizations
- Bills of quantities



Engineering applications

- As-built documentation
- BIM
- Facility Management
- Finite Element Analysis
- Computational Fluid Dynamics
- 3D Comparison
- 3D monitoring
- 3D Collision check
- 3D Fabrication
- 3D Prototyping
- 3D Printing
- Volumetric Surveys

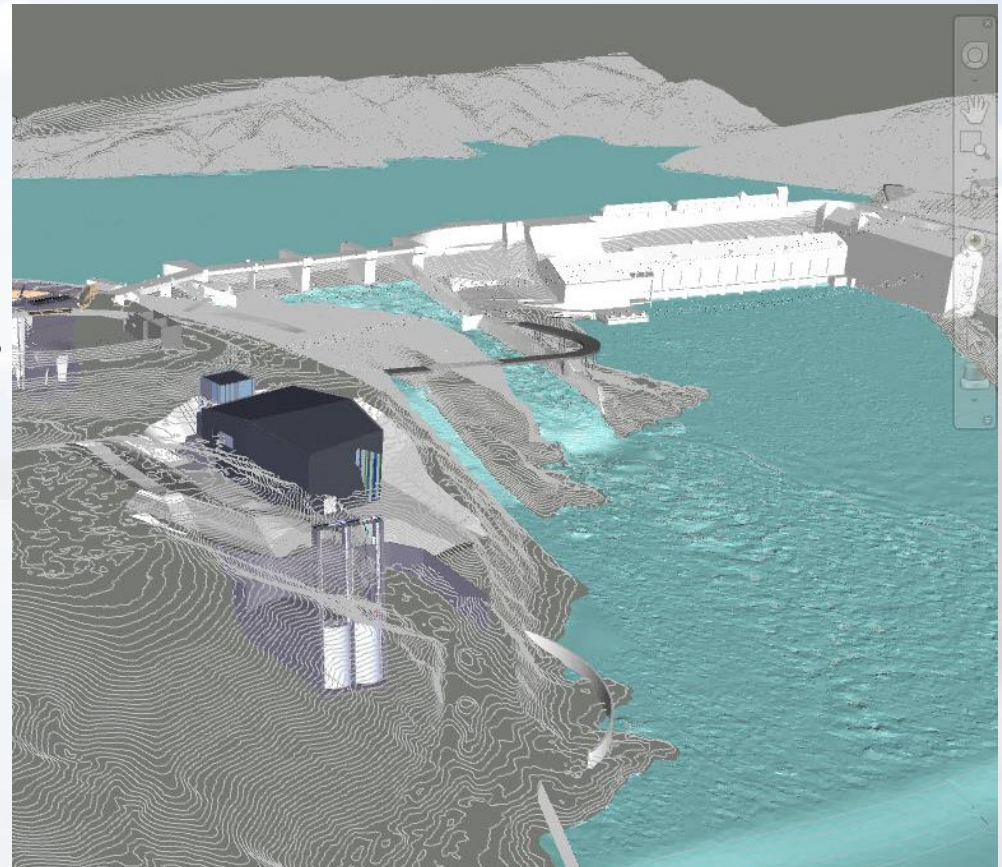



FIG Working Week 2016

CHRISTCHURCH, NEW ZEALAND 2-6 MAY 2016

Recovery

from disaster

Our Team



Anders Nesse,
Photogrammetry



Ulf Hägnefelt,
3D Scanning



Artemis Valanis,
BIM modelling,
photogrammetry



FIG Working Week 2016

CHRISTCHURCH, NEW ZEALAND 2-6 MAY 2016

Recovery

from disaster

- 2900 employees
- 80 offices in 11 countries
- NOK 3,8 billions in revenue *

* Pr. 01.01.2015

100%

Norconsult AS

Norconsult is Norway's and one of the Nordic countries' leading multidisciplinary engineering and design consultancies

88%	100%	100%
Norconsult LNG AS	Technogarden Engineering Resources (Norway, Sweden)	Norconsult Informasjonsstemer AS
		Norconsult Astando AB

100%	100%	100%
Norconsult AB (Sweden)	Norconsult A/S (Denmark)	Solem Arkitektur AS
Norconsult Fältgeoteknik AB		

100%	100%	95%	100%	100%	24,5%	100%	100%	100%
Norconsult Africa (Pty) Ltd (South-Africa)	Norconsult Mozambique Lda	SCDS Lda (Mozambique)	Norconsult Management Services Phil. Inc	Norconsult Laos Co. Ltd	NorCiv Engineering Co. Ltd (Thailand)	NorPower Sdn Bhd (Malaysia)	Norconsult Andina SA (Chile)	Norconsult Peru SAC



Platinum Partners:



Diamond Partner





FIG Working Week 2016

CHRISTCHURCH, NEW ZEALAND 2-6 MAY 2016

Recovery

from disaster

More than 50 years of international experience

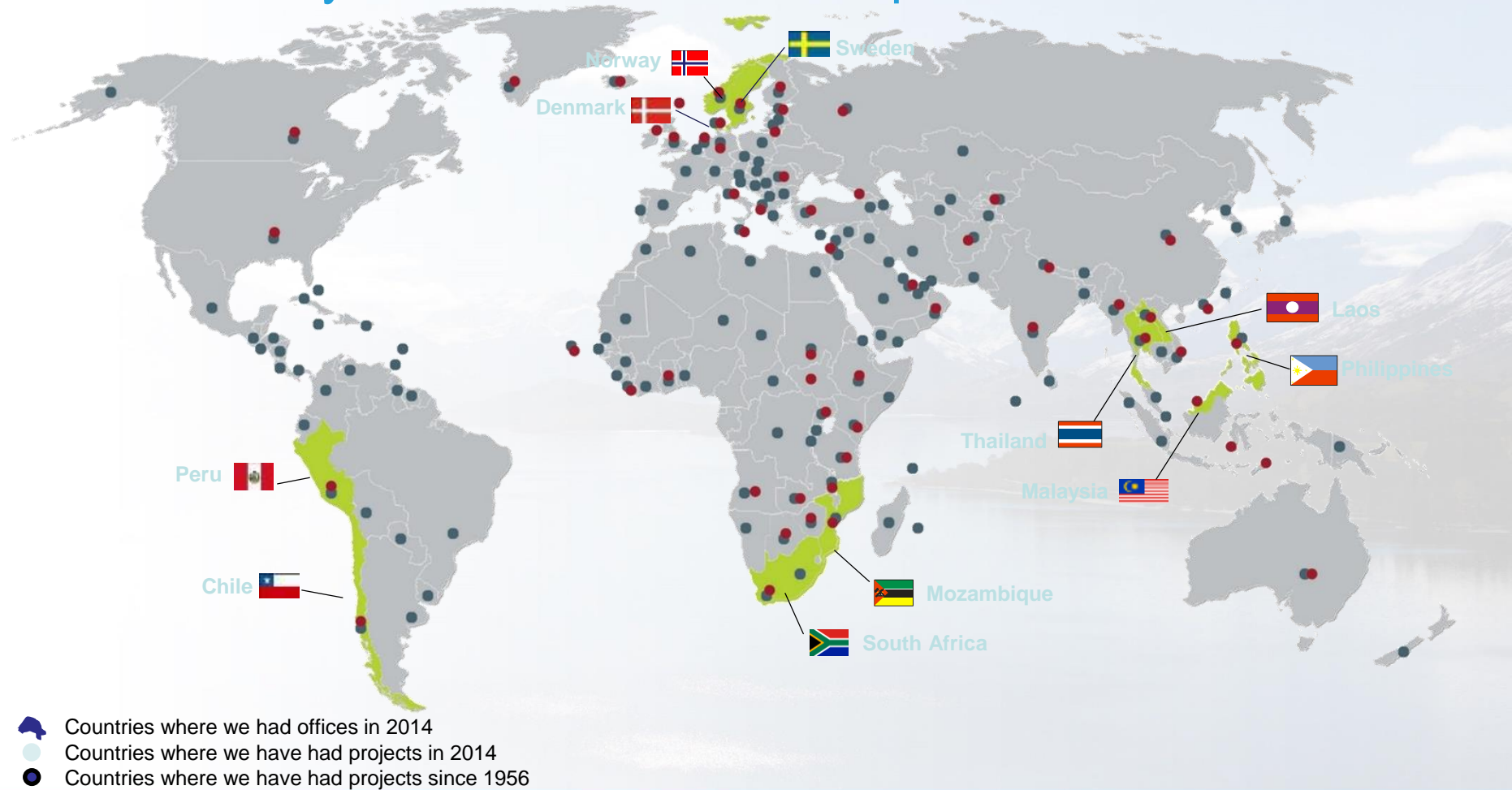

Platinum Partners:



Diamond Partner





3 projects case studies

- A Project on New Construction Design
- A Rehabilitation Project
- A 3D Documentation Project

Example projects 1/3

New Construction Design



Project description:

- New hydropower plant
- The biggest of its kind
- Entirely designed in 3D as a BIM model
- A Completely Paperless Project
- 1 sq Km Project Area
- Aerial and terrestrial Laser Scanning, Aerial and Ground image data, GIS data, Geodetic surveys



FIG Working Week 2016

CHRISTCHURCH, NEW ZEALAND 2-6 MAY 2016

Recovery

from disaster



Platinum Partners:



Diamond Partner



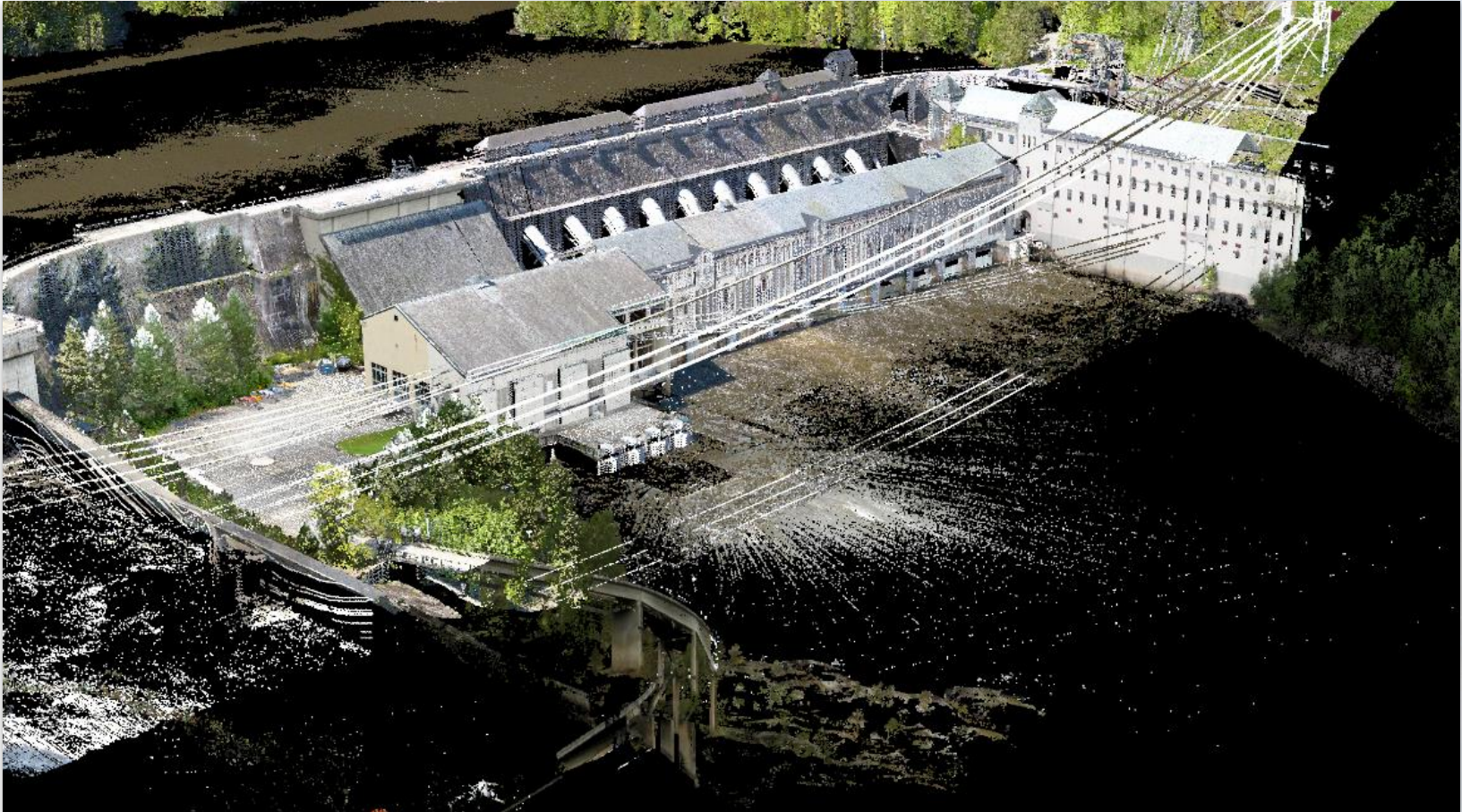

FIG Working Week 2016

CHRISTCHURCH, NEW ZEALAND 2-6 MAY 2016

Recovery

from disaster



Platinum Partners:



Diamond Partner



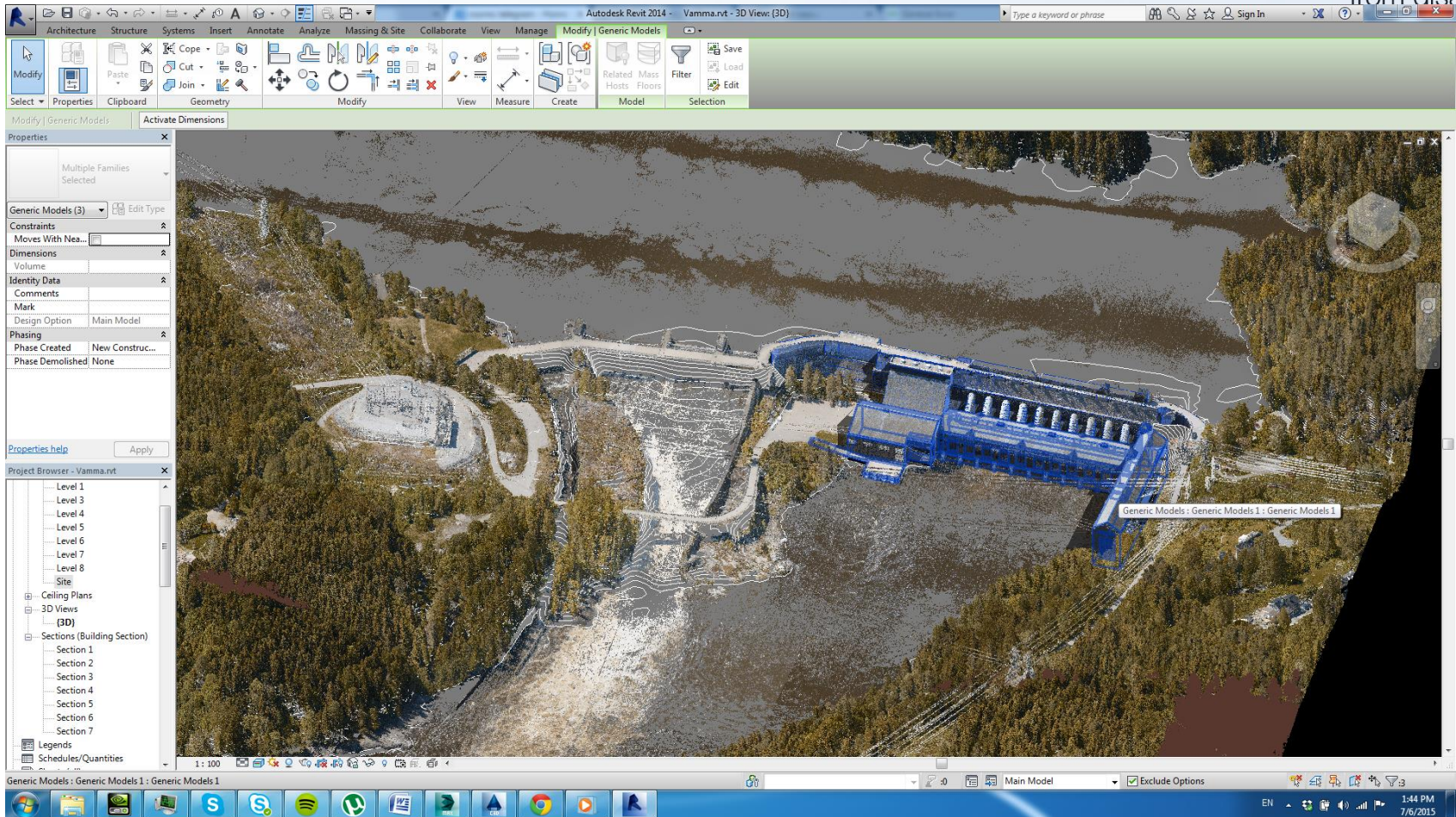

FIG Working Week 2016

CHRISTCHURCH, NEW ZEALAND 2-6 MAY 2016

Recovery

from disaster



Platinum Partners:



Diamond Partner



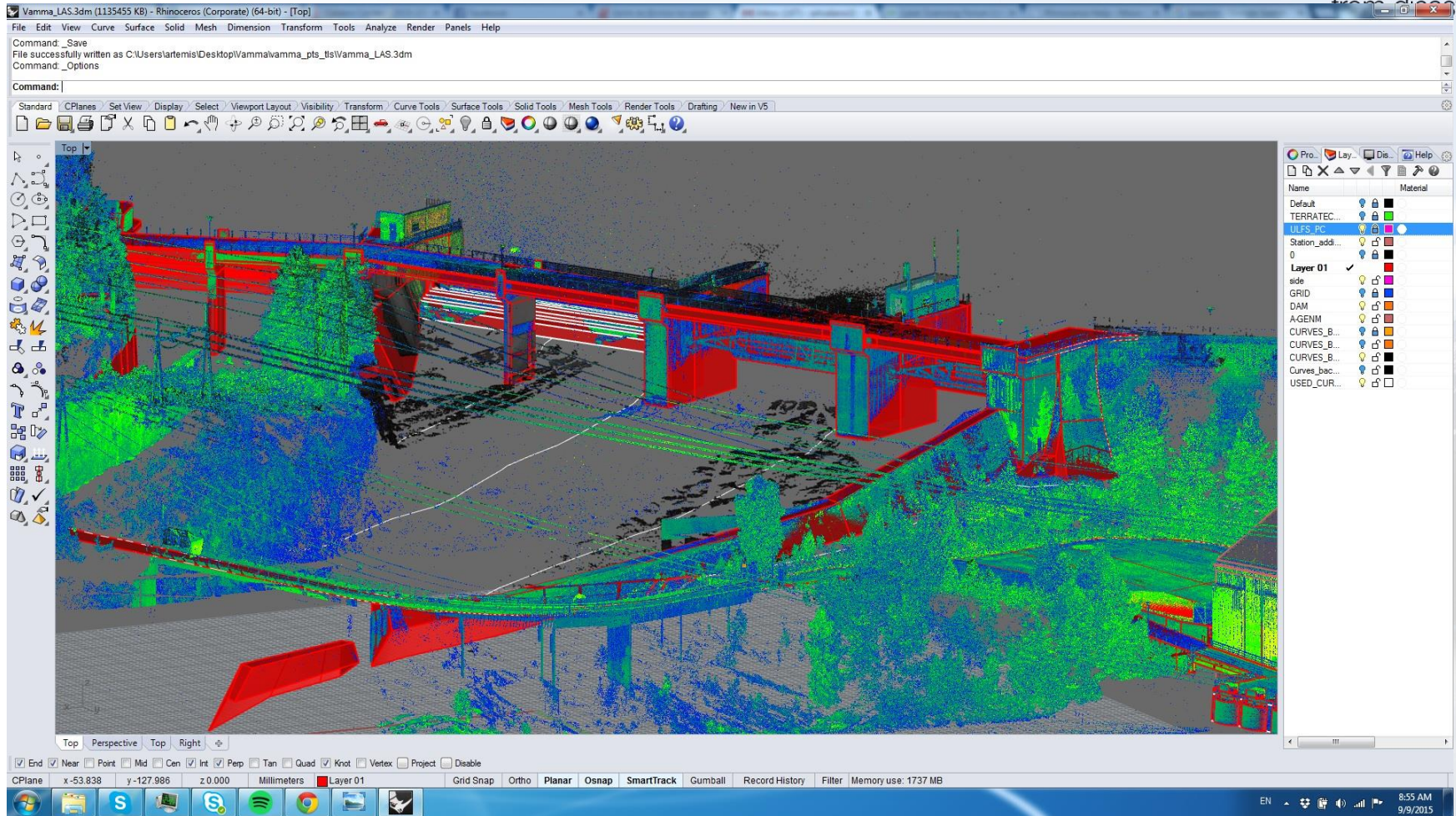

FIG Working Week 2016

CHRISTCHURCH, NEW ZEALAND 2-6 MAY 2016

Recovery

from indicator



Platinum Partners:



Diamond Partner



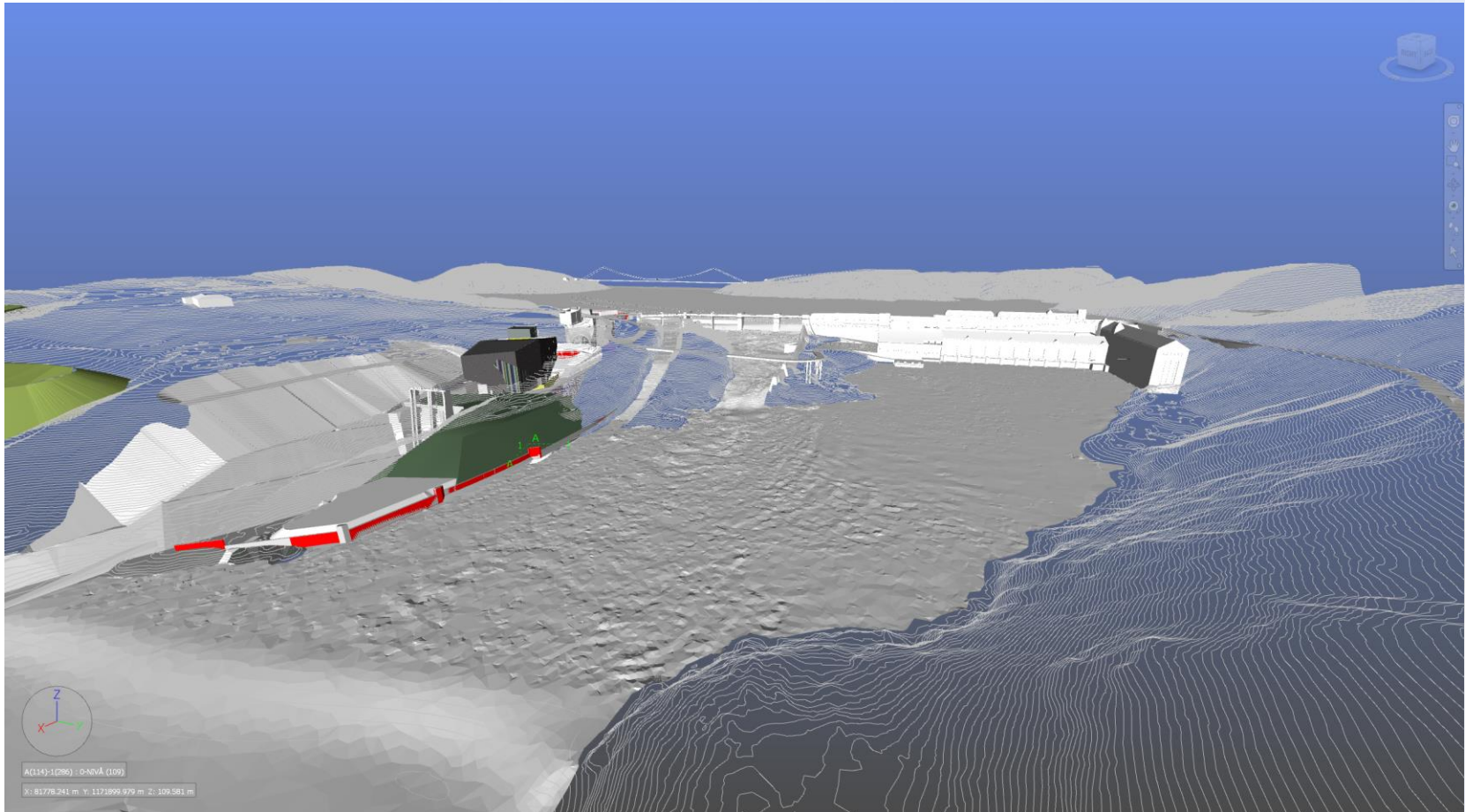

FIG Working Week 2016

CHRISTCHURCH, NEW ZEALAND 2-6 MAY 2016

Recovery

from disaster



Platinum Partners:



Diamond Partner



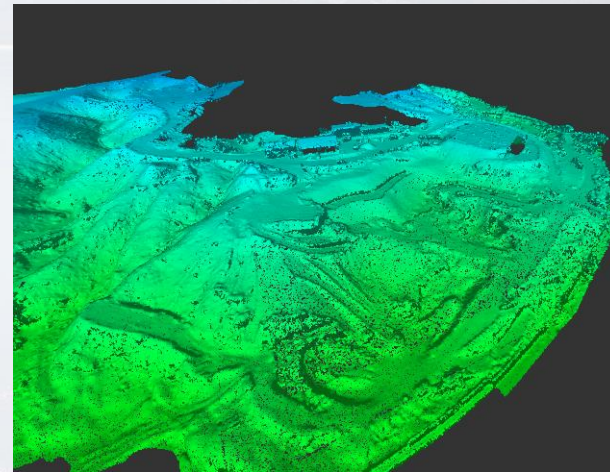
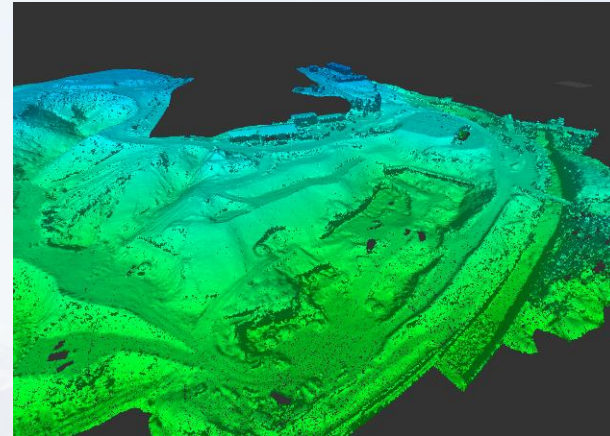
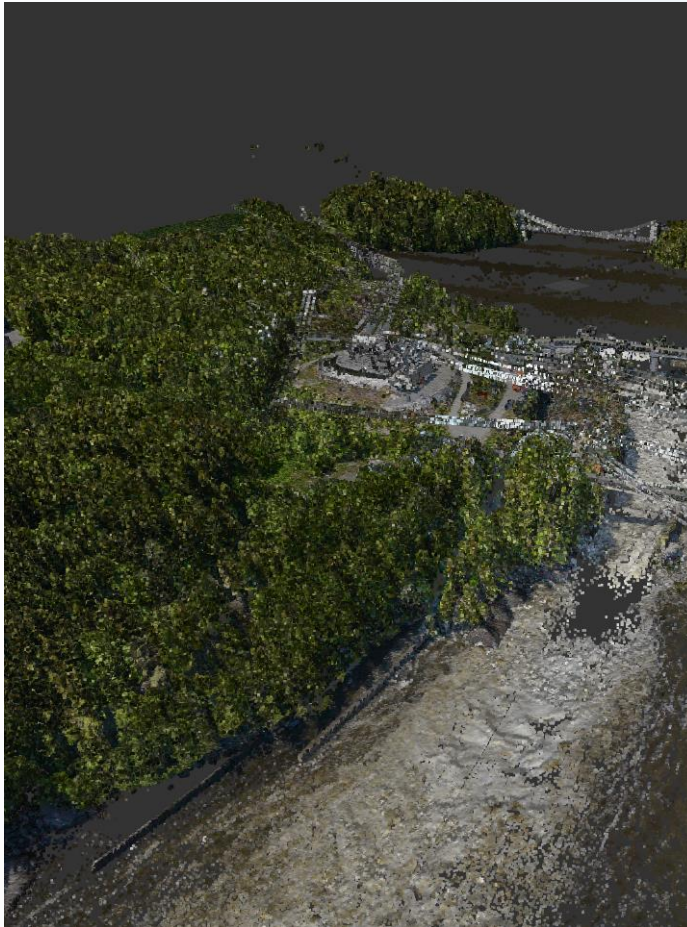

FIG Working Week 2016

CHRISTCHURCH, NEW ZEALAND 2-6 MAY 2016

Recovery

from disaster



Platinum Partners:



Diamond Partner





FIG Working Week 2016

CHRISTCHURCH, NEW ZEALAND 2-6 MAY 2016

Recovery

from disaster



Example projects 2/3

A Rehabilitation Project



Project description:

- Large project for rehabilitation and upgrade of a number of plants
- 3D documentation and modeling of a hydropower station including the existing waterways
- Terrestrial Laser Scanning and use of ROV for scanning the waterways



FIG Working Week 2016

CHRISTCHURCH, NEW ZEALAND 2-6 MAY 2016

Recovery

from disaster

Existing Data

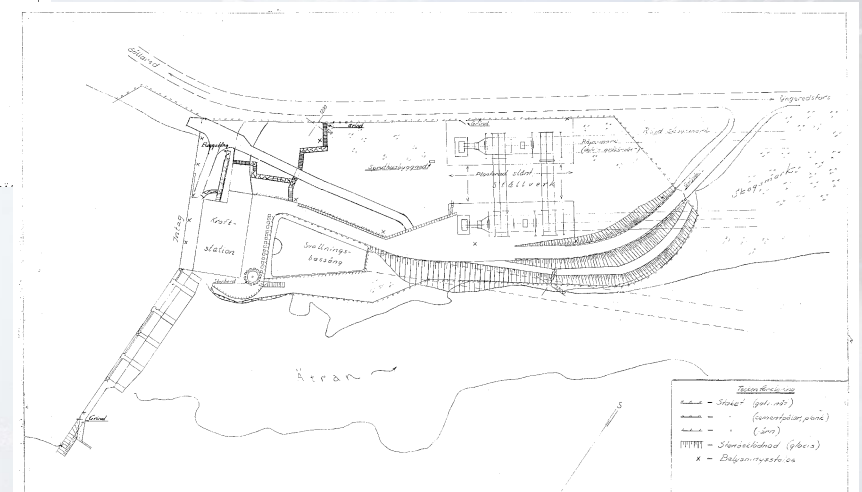
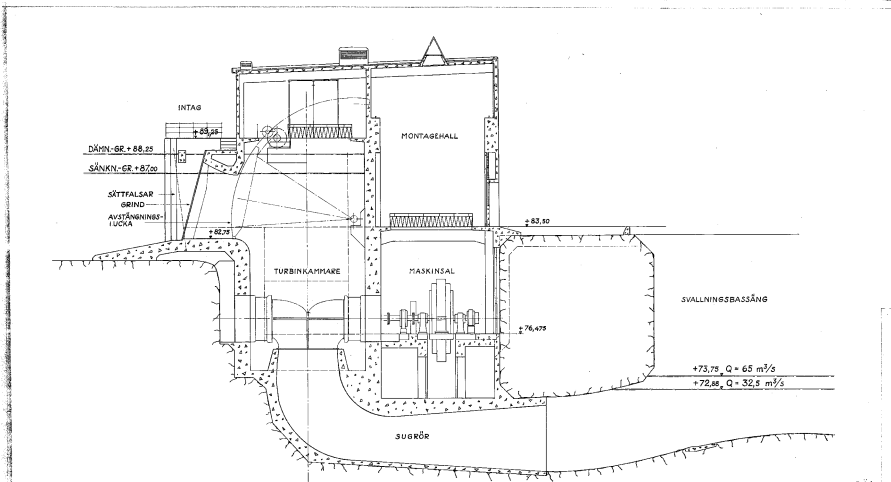



FIG Working Week 2016

CHRISTCHURCH, NEW ZEALAND 2-6 MAY 2016

Recovery

from disaster

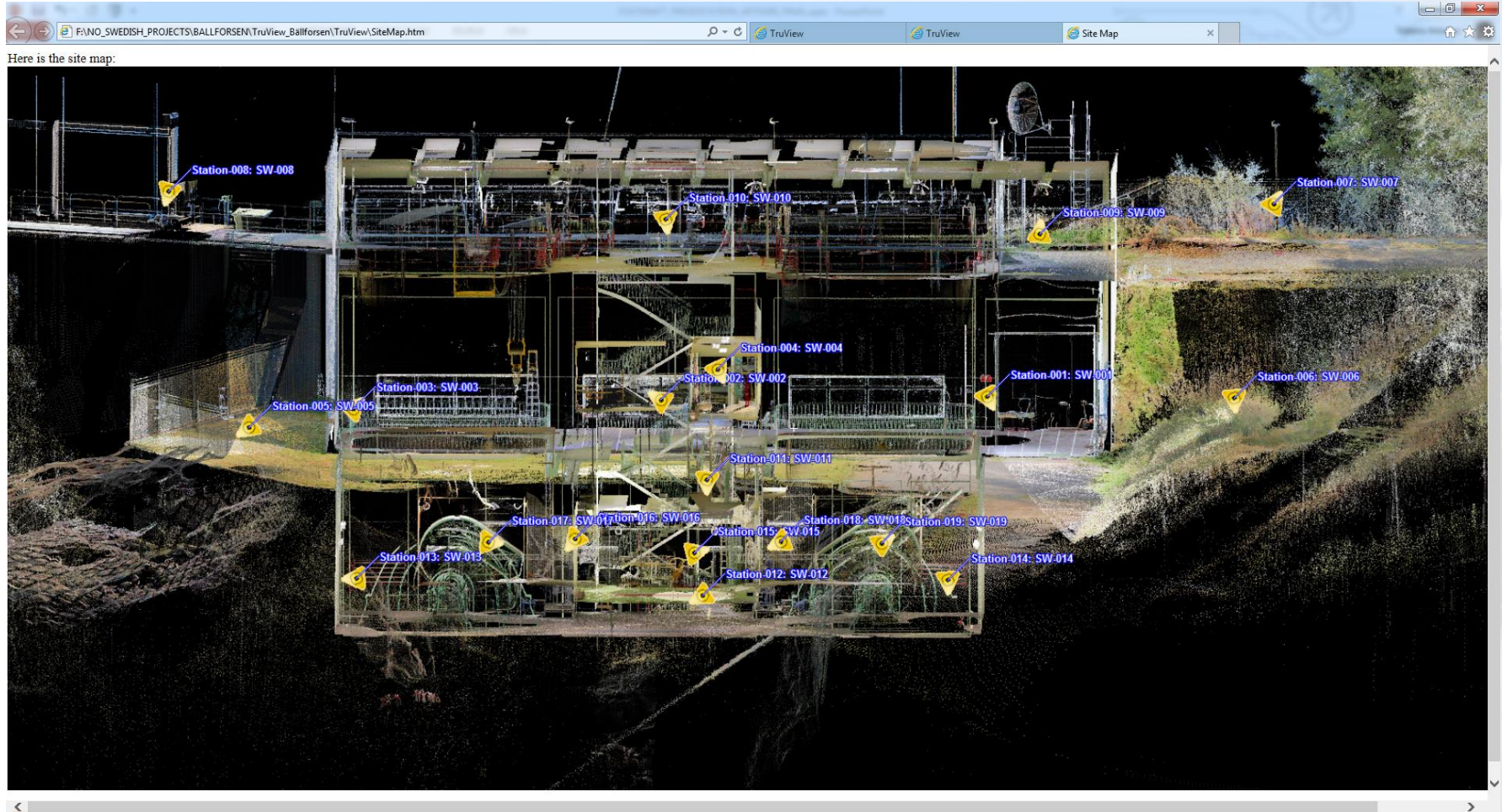

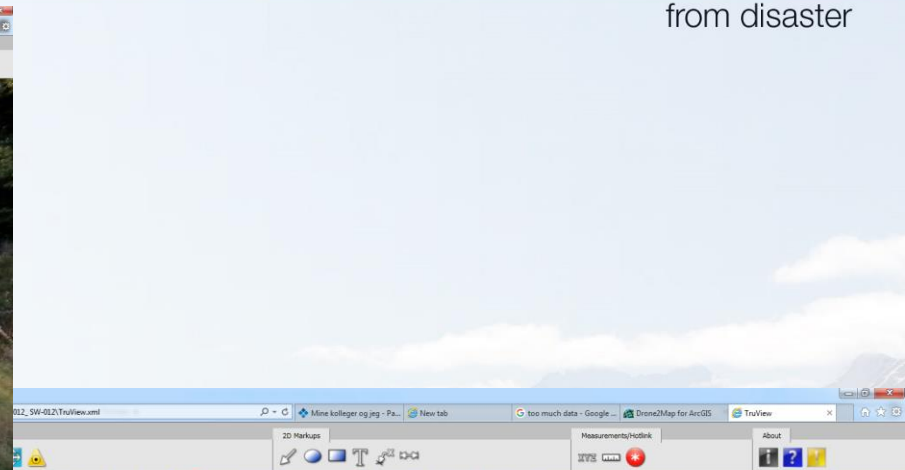
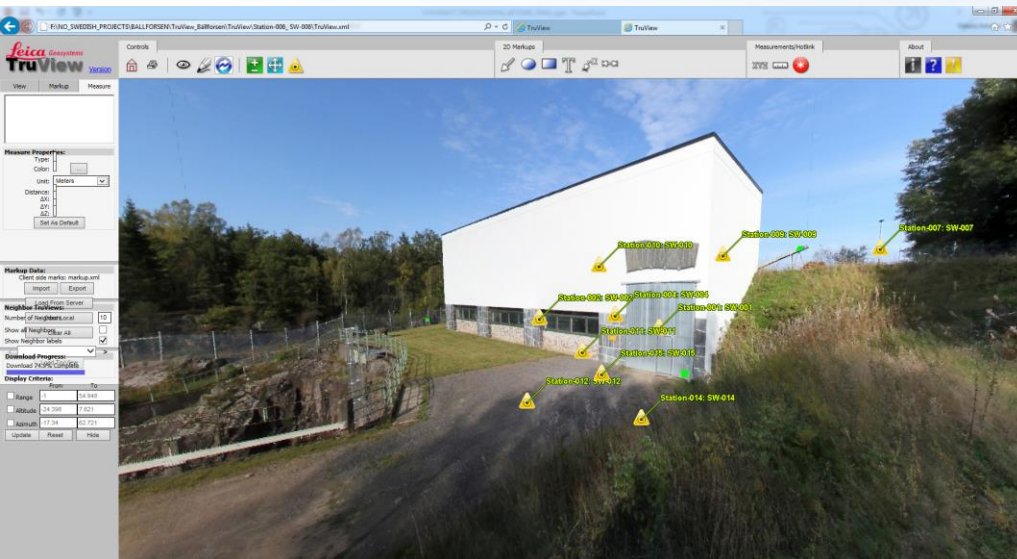

FIG Working Week 2016

CHRISTCHURCH, NEW ZEALAND 2-6 MAY 2016

Recovery

from disaster



Platinum Partners:



Diamond Partner





FIG Working Week 2016

CHRISTCHURCH, NEW ZEALAND 2-6 MAY 2016

Recovery

from disaster





FIG Working Week 2016

CHRISTCHURCH, NEW ZEALAND 2-6 MAY 2016

Recovery

from disaster

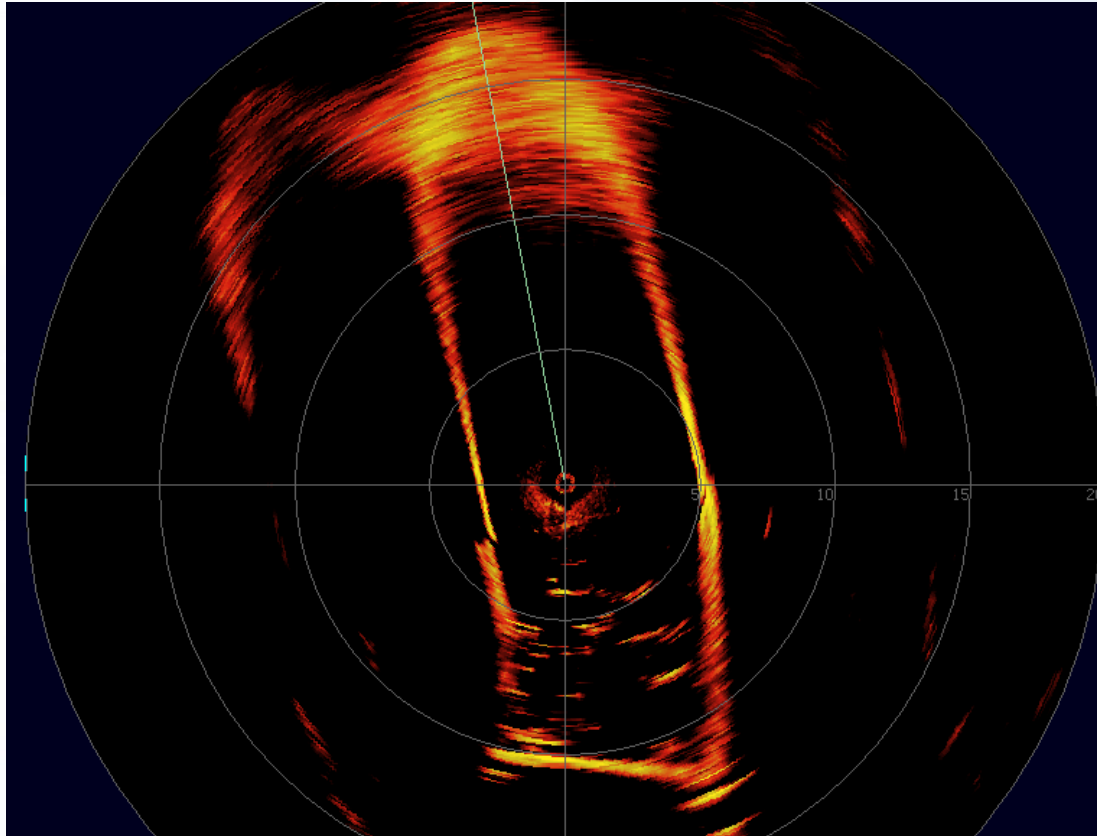



FIG Working Week 2016

CHRISTCHURCH, NEW ZEALAND 2-6 MAY 2016

Recovery

from disaster

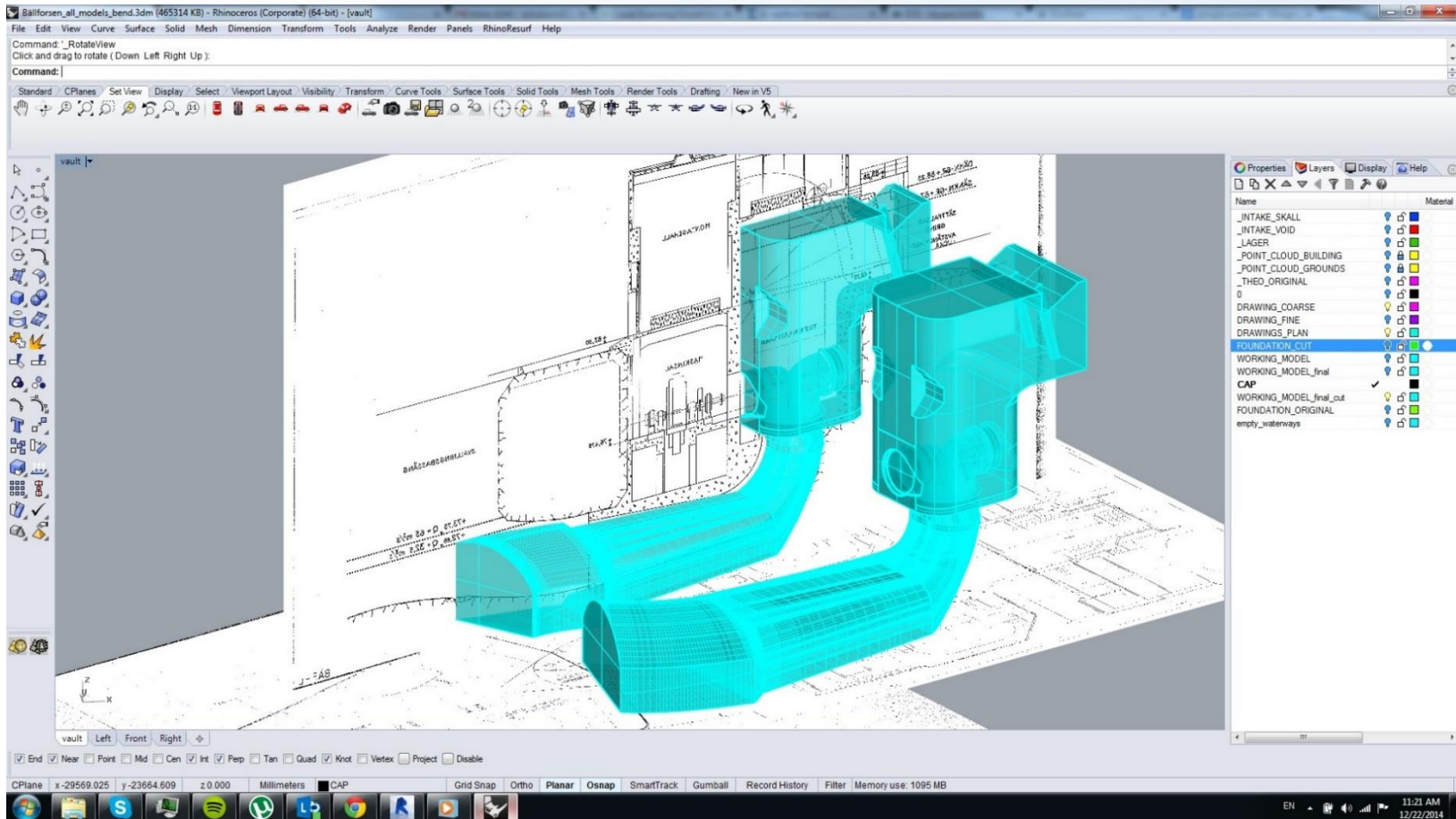

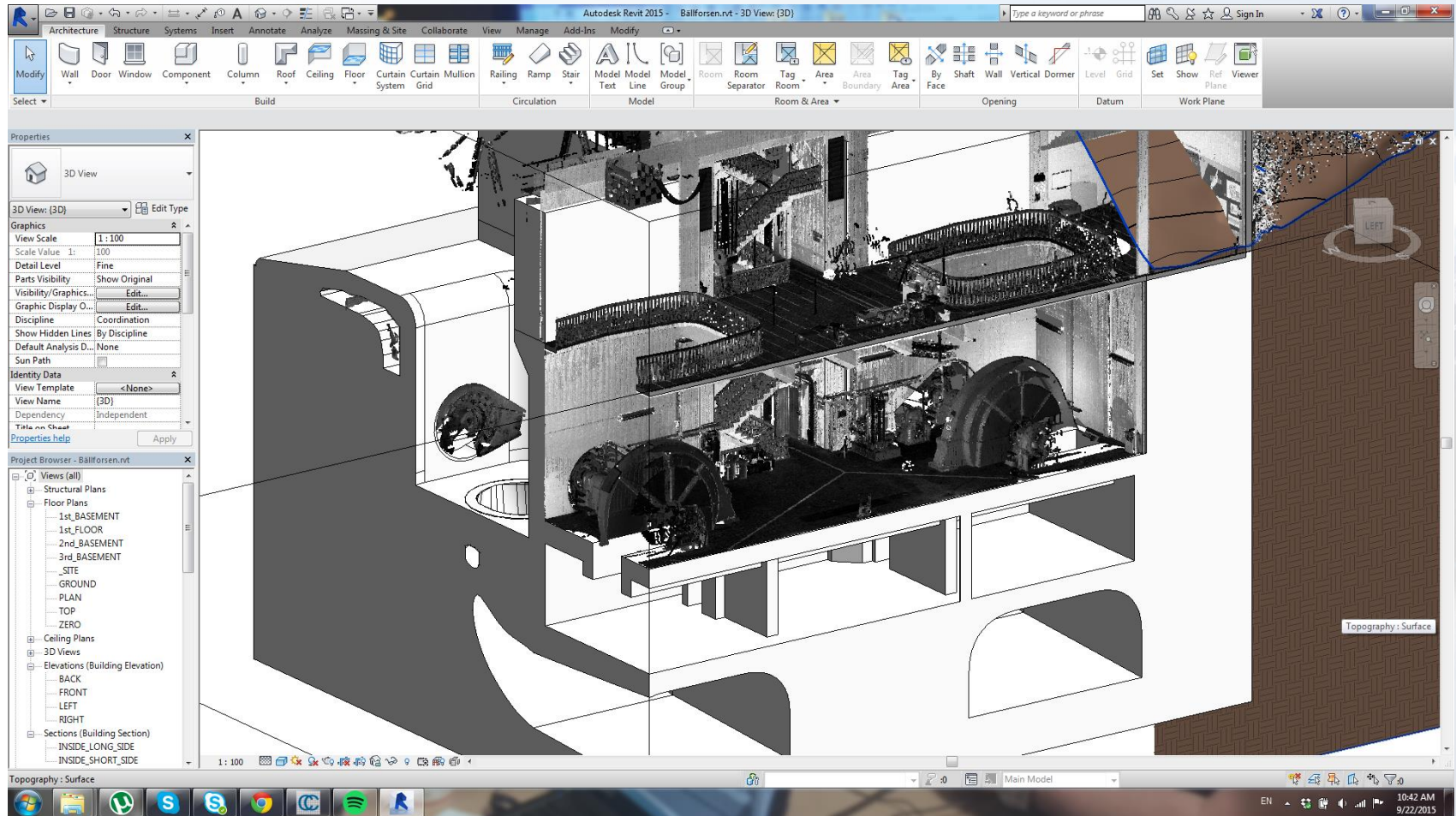

FIG Working Week 2016

CHRISTCHURCH, NEW ZEALAND 2-6 MAY 2016

Recovery

from disaster



Platinum Partners:



Diamond Partner



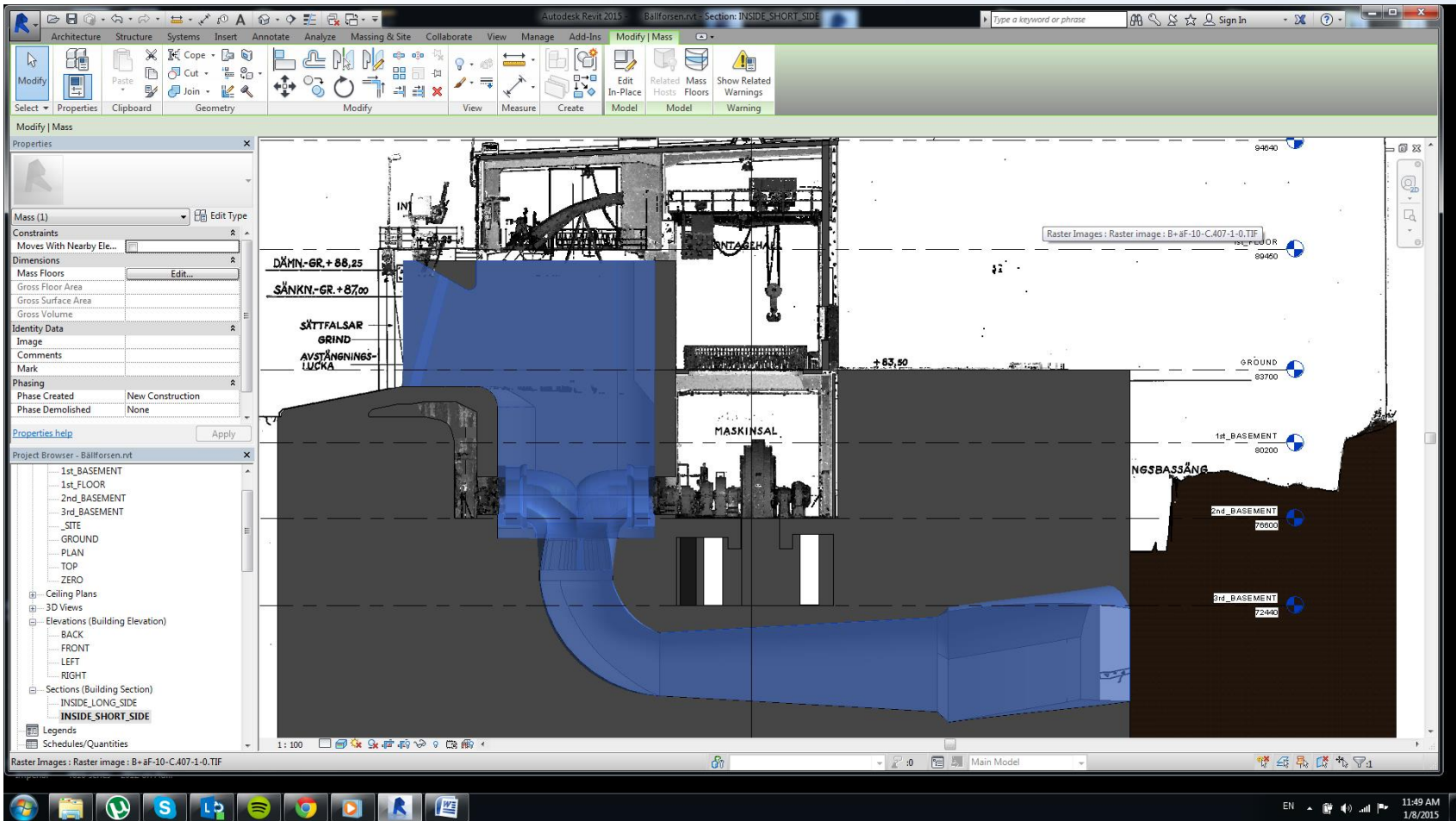

FIG Working Week 2016

CHRISTCHURCH, NEW ZEALAND 2-6 MAY 2016

Recovery

from disaster



Platinum Partners:



Diamond Partner



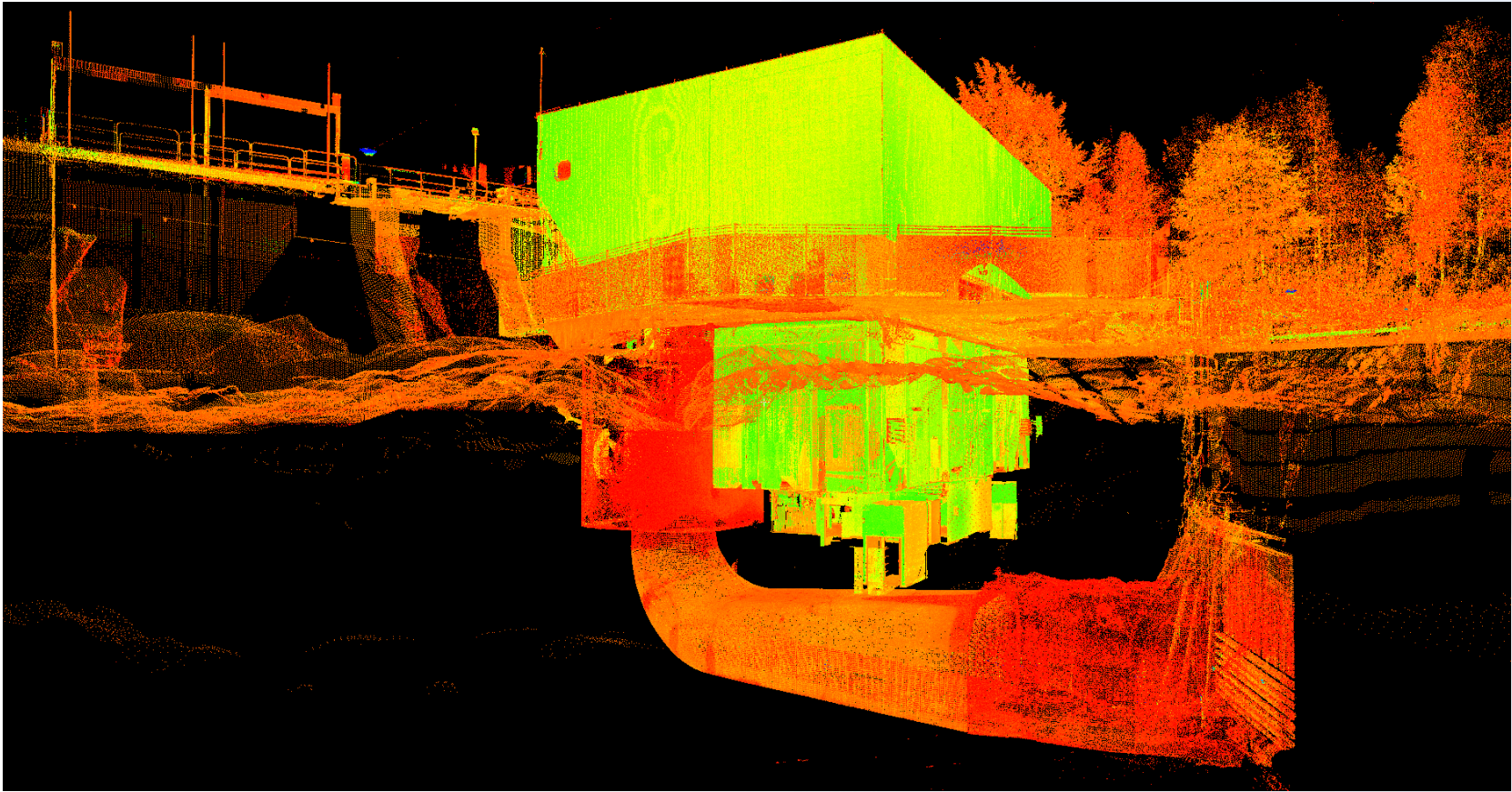

FIG Working Week 2016

CHRISTCHURCH, NEW ZEALAND 2-6 MAY 2016

Recovery

from disaster



Platinum Partners:



Diamond Partner



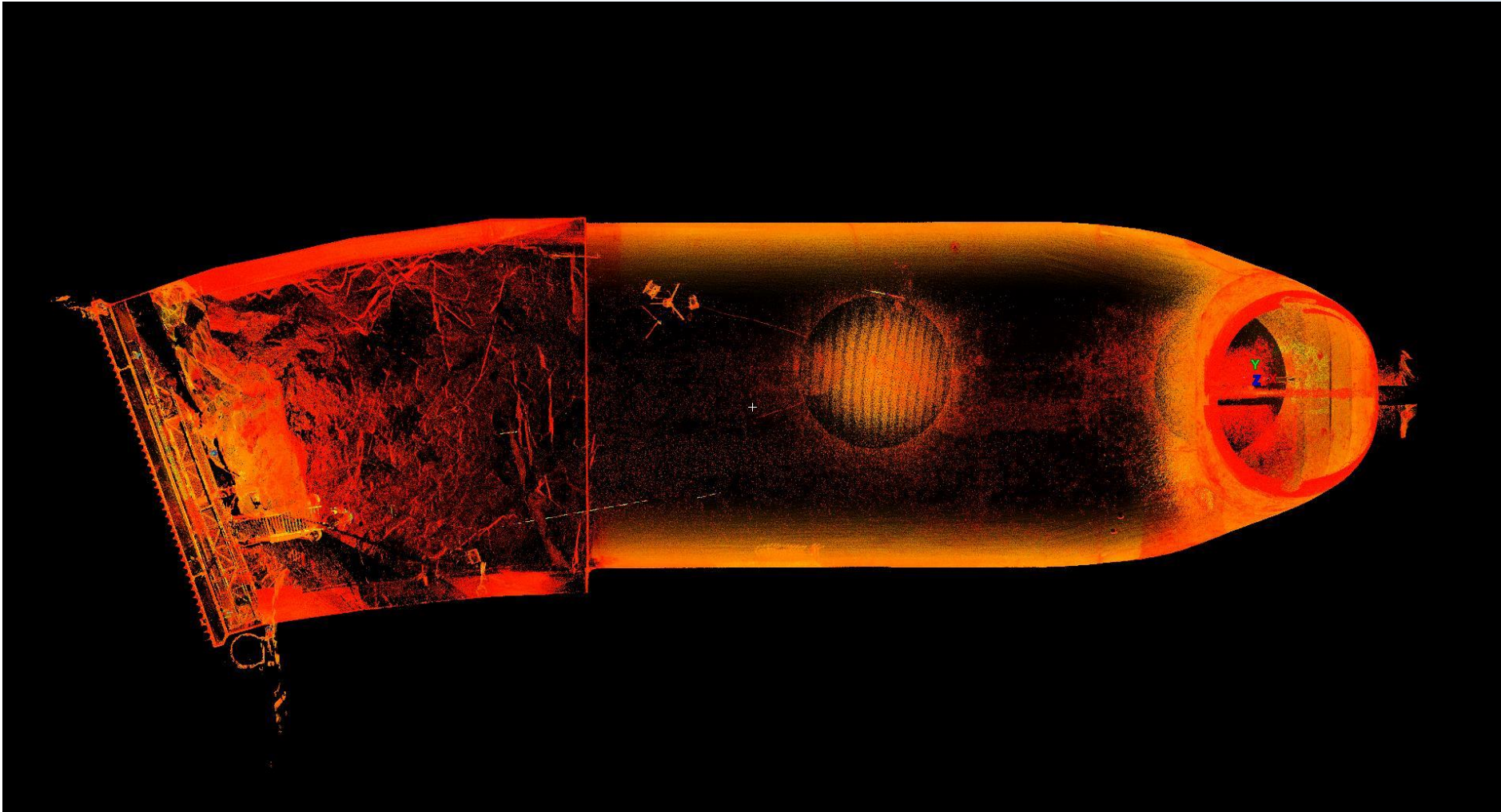

FIG Working Week 2016

CHRISTCHURCH, NEW ZEALAND 2-6 MAY 2016

Recovery

from disaster



Platinum Partners:



Diamond Partner



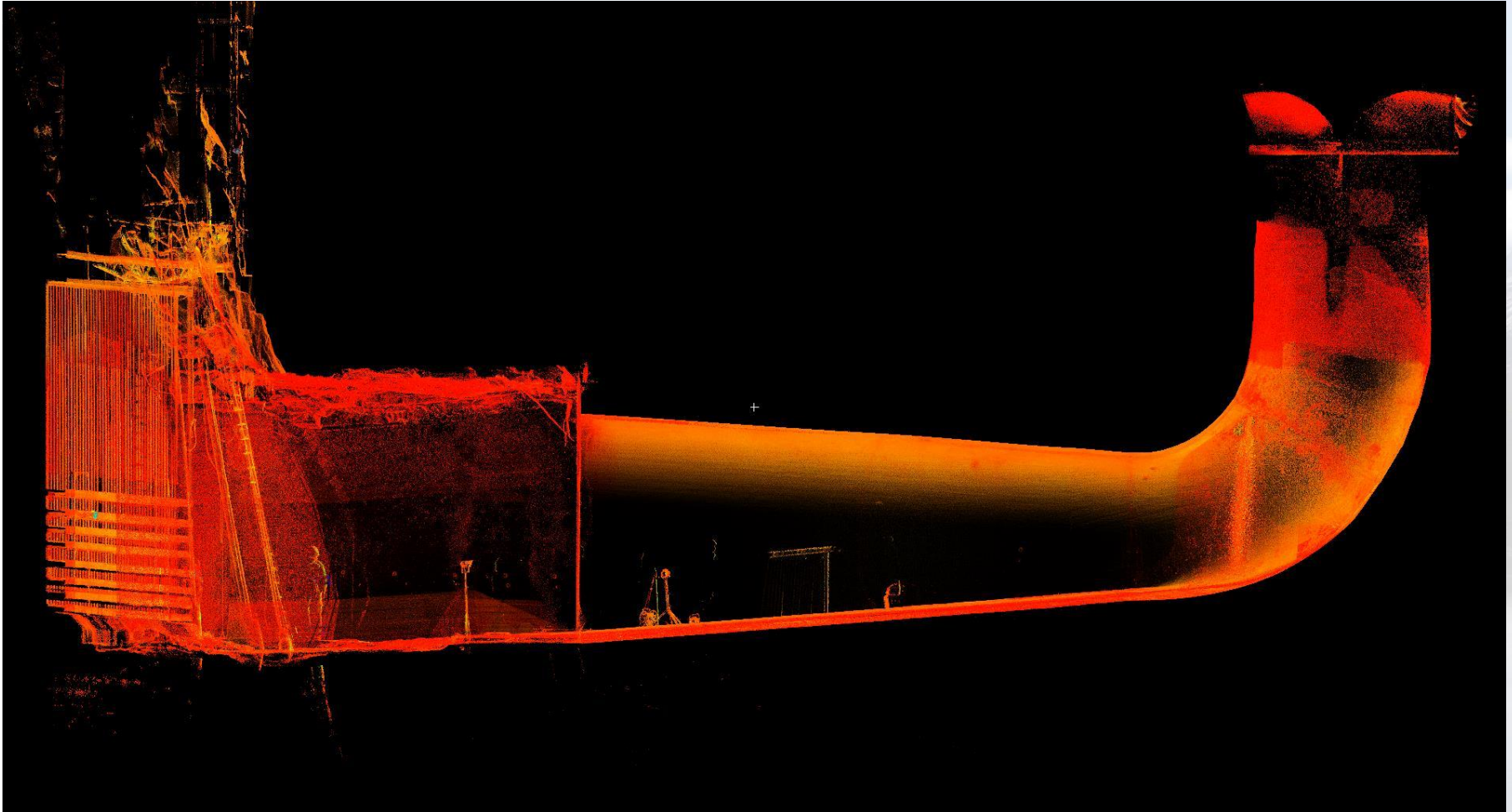

FIG Working Week 2016

CHRISTCHURCH, NEW ZEALAND 2-6 MAY 2016

Recovery

from disaster



Platinum Partners:



Diamond Partner



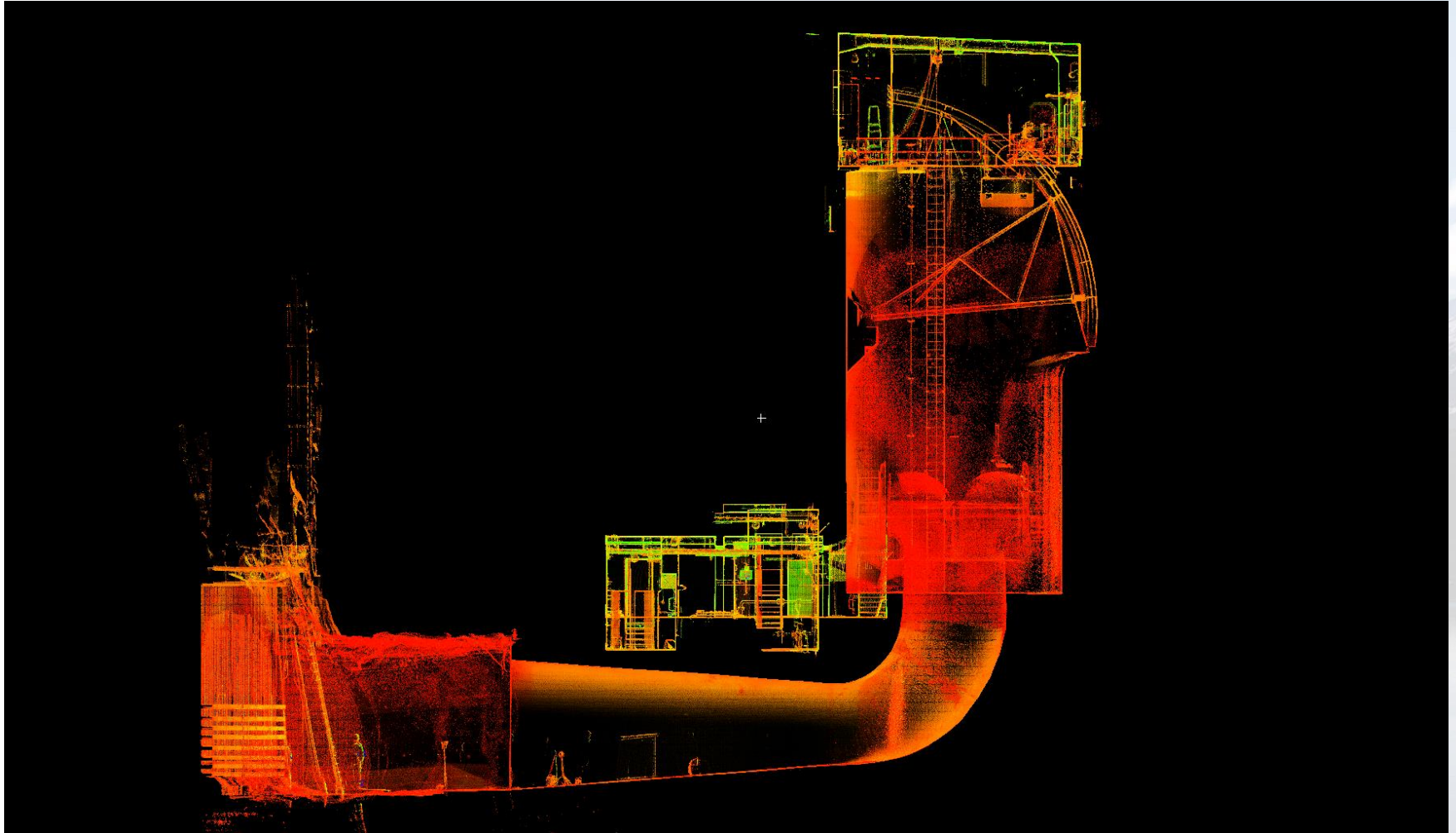

FIG Working Week 2016

CHRISTCHURCH, NEW ZEALAND 2-6 MAY 2016

Recovery

from disaster



Platinum Partners:



Diamond Partner





FIG Working Week 2016

CHRISTCHURCH, NEW ZEALAND 2-6 MAY 2016

Recovery

from disaster

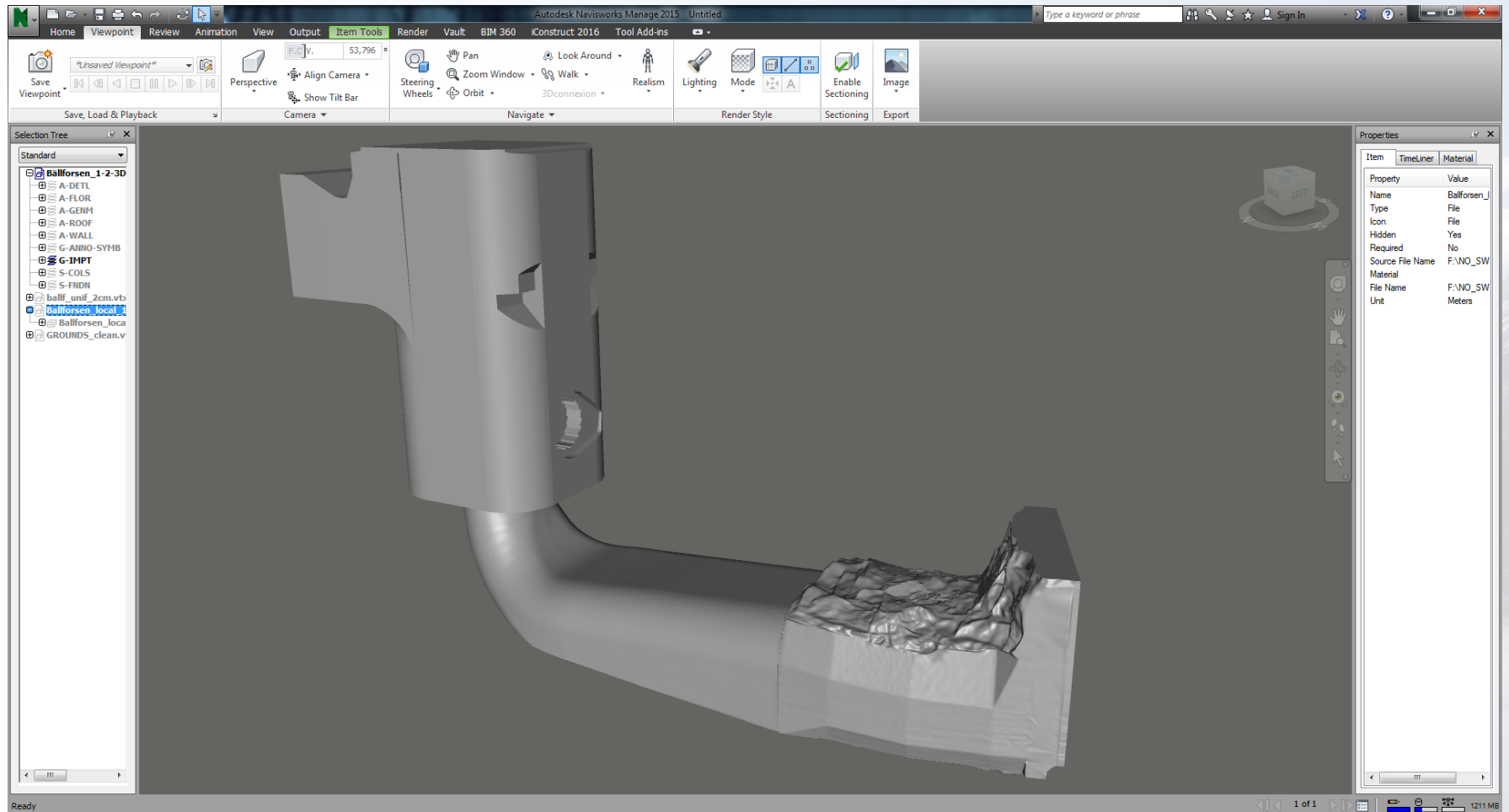

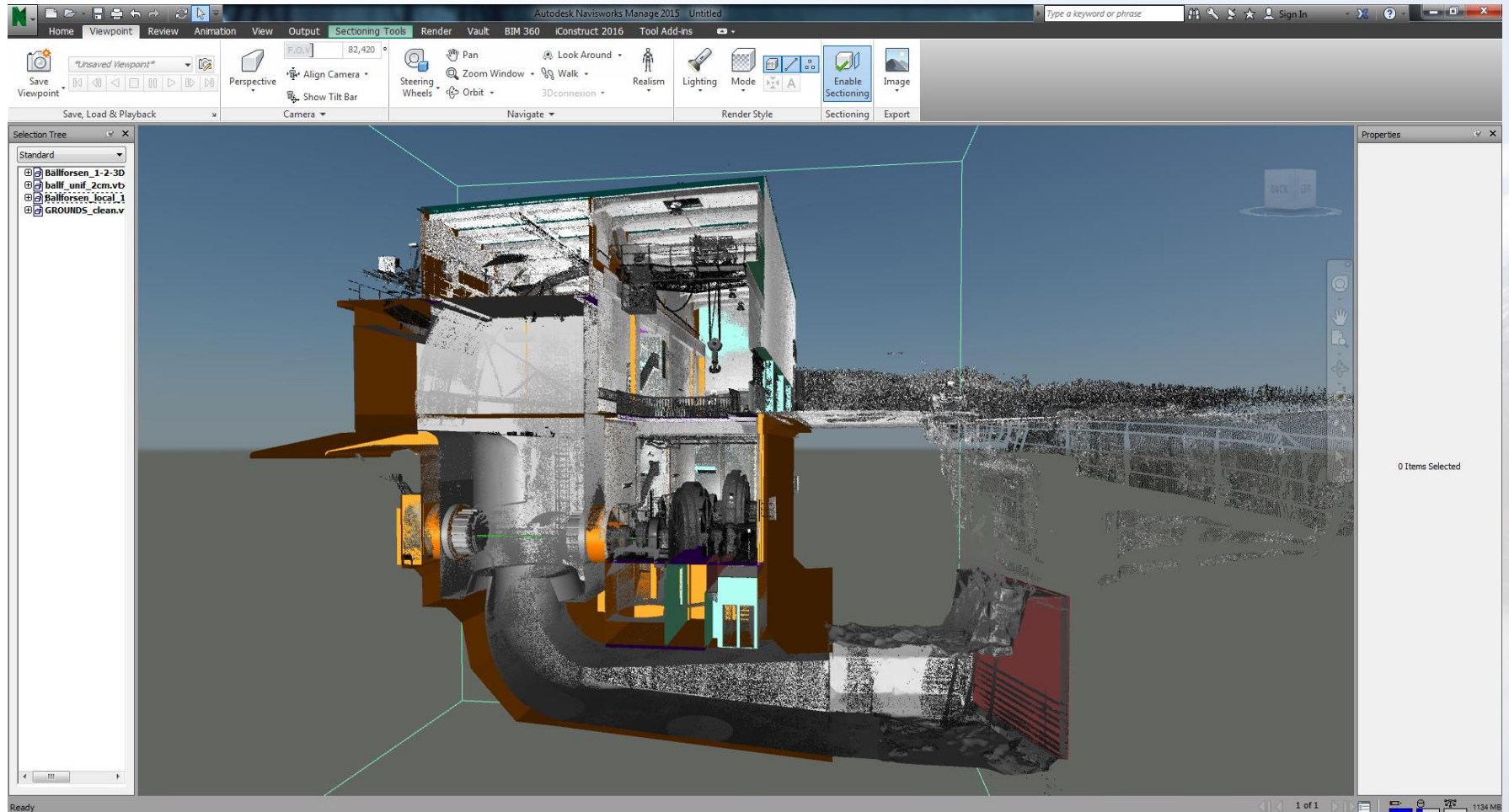

FIG Working Week 2016

CHRISTCHURCH, NEW ZEALAND 2-6 MAY 2016

Recovery

from disaster



Platinum Partners:



Diamond Partner



Example projects 3/3

A 3D Documentation Project



Project description:

- part of a bigger project
- documentation, rehabilitation and upgrade of several power stations, including distribution power lines
- DEM data, orthophotos, GIS data and laser scanning for a number of stations
- Combination and processing of data into AutoCAD, Revit and Infraworks
- Focus on 3D documentation and modeling of an electric substation

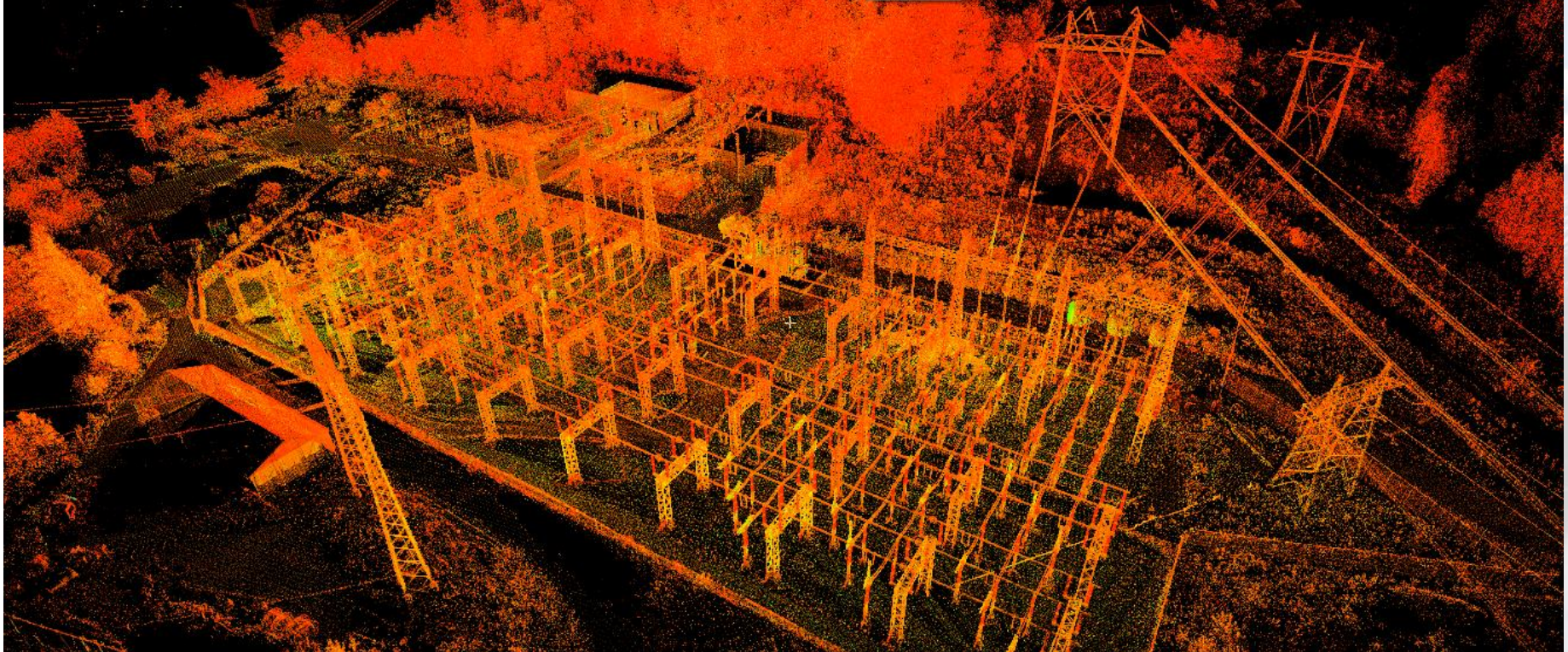

FIG Working Week 2016

CHRISTCHURCH, NEW ZEALAND 2-6 MAY 2016

Recovery

from disaster



Platinum Partners:



Diamond Partner



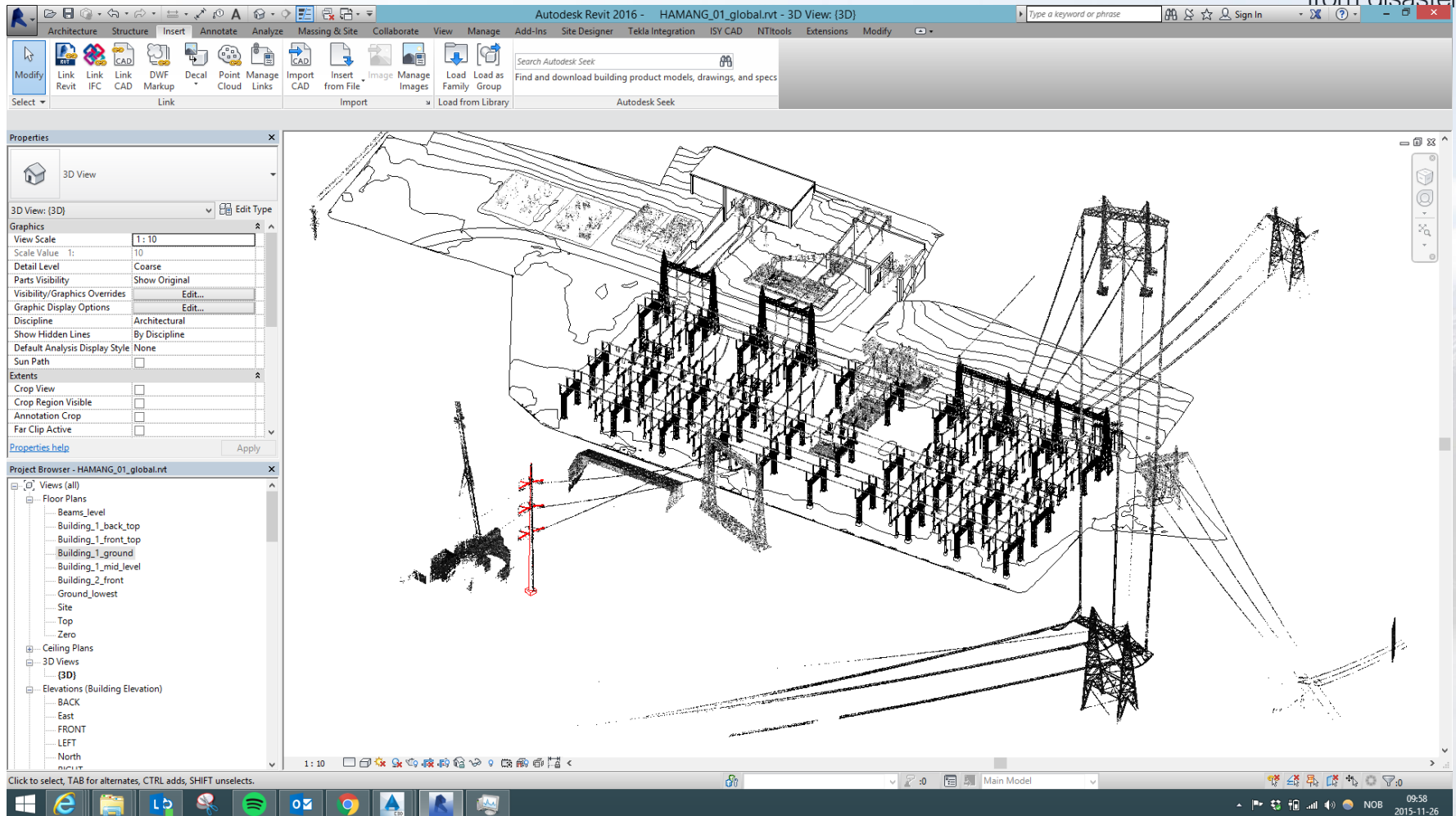

FIG Working Week 2016

CHRISTCHURCH, NEW ZEALAND 2-6 MAY 2016

Recovery

from disaster



Platinum Partners:



Diamond Partner



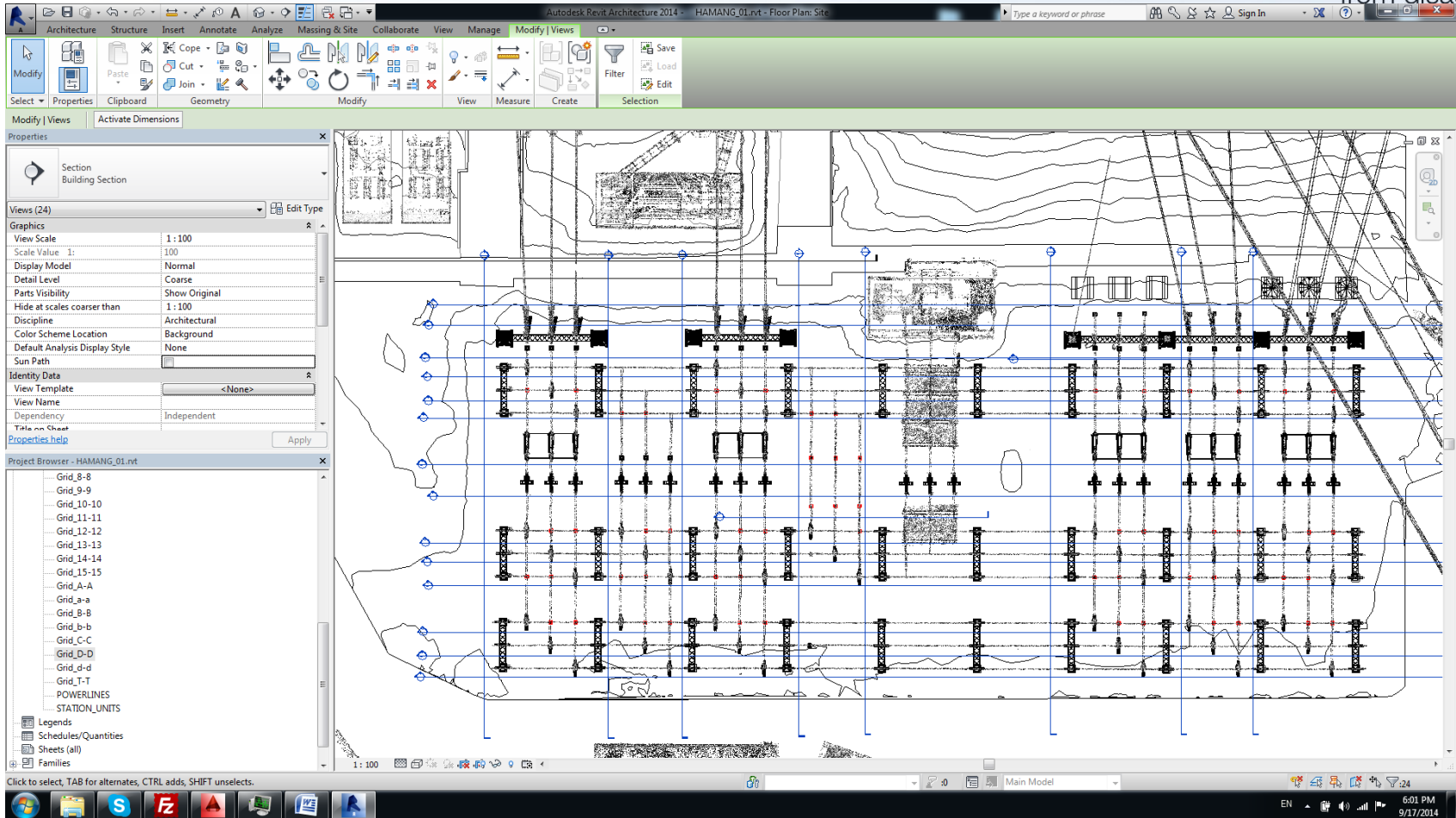

FIG Working Week 2016

CHRISTCHURCH, NEW ZEALAND 2-6 MAY 2016

Recovery

from disaster



Platinum Partners:



Diamond Partner



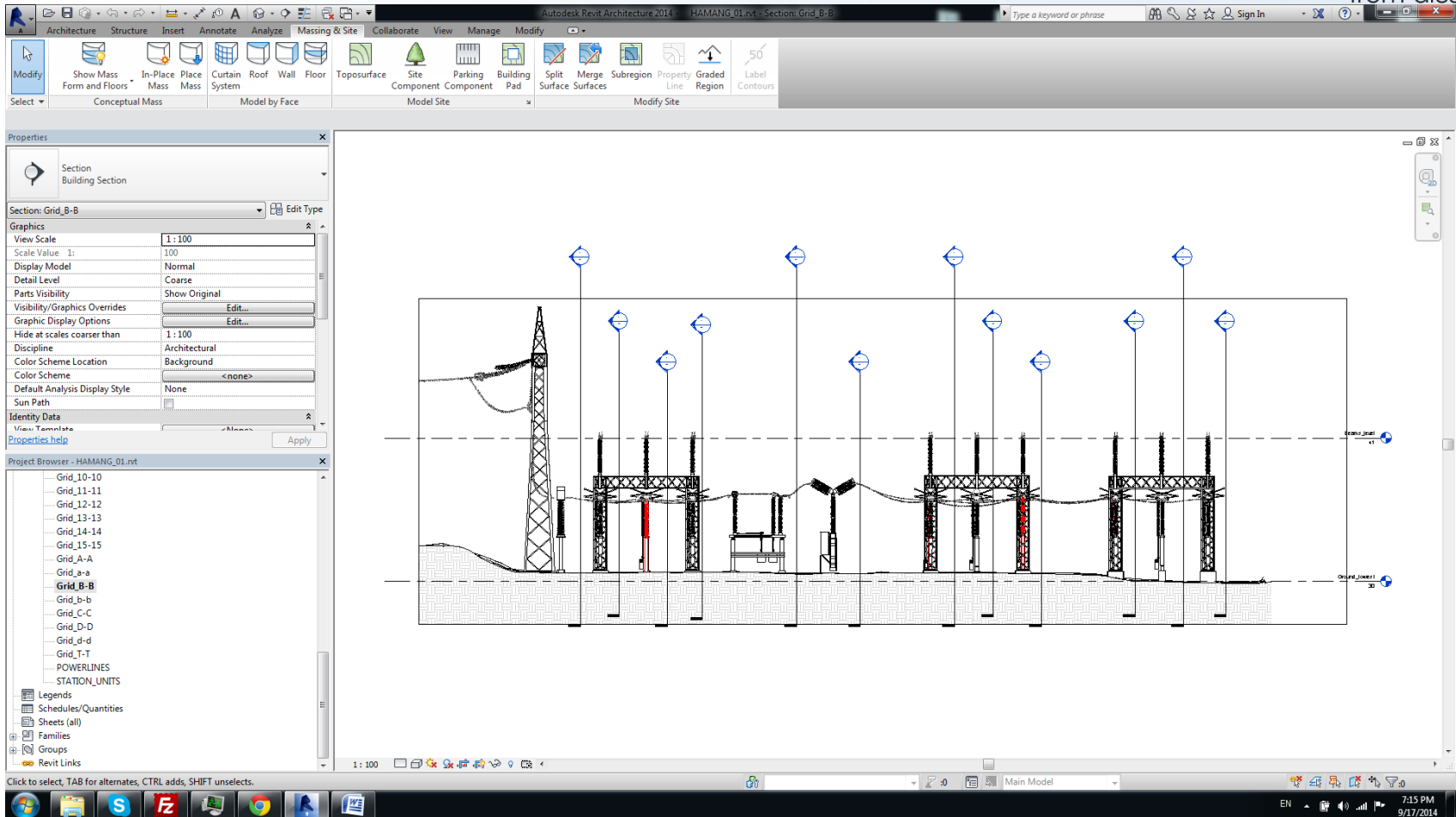

FIG Working Week 2016

CHRISTCHURCH, NEW ZEALAND 2-6 MAY 2016

Recovery

from disaster





Conclusions

3D Data Acquisition and Modeling for the Energy Sector

- An exciting and challenging area for surveyors
- A very wide range of applications and possibilities
- Constant requirement for high quality data, new workflows, data fusion and integration of processes

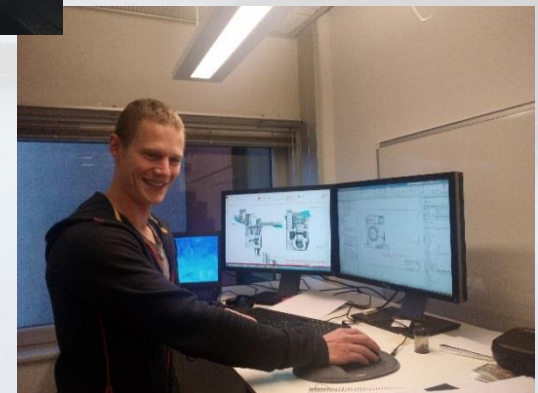
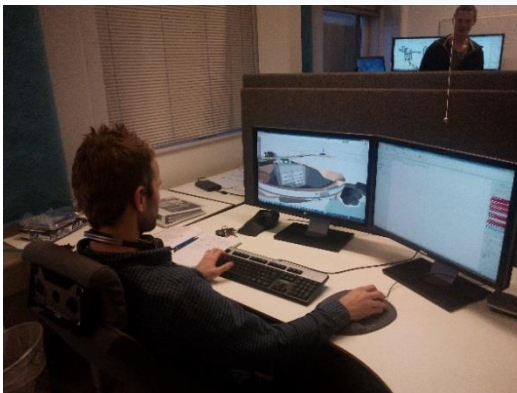

FIG Working Week 2016

CHRISTCHURCH, NEW ZEALAND 2-6 MAY 2016

Recovery

from disaster



Platinum Partners:



Diamond Partner



Norconsult

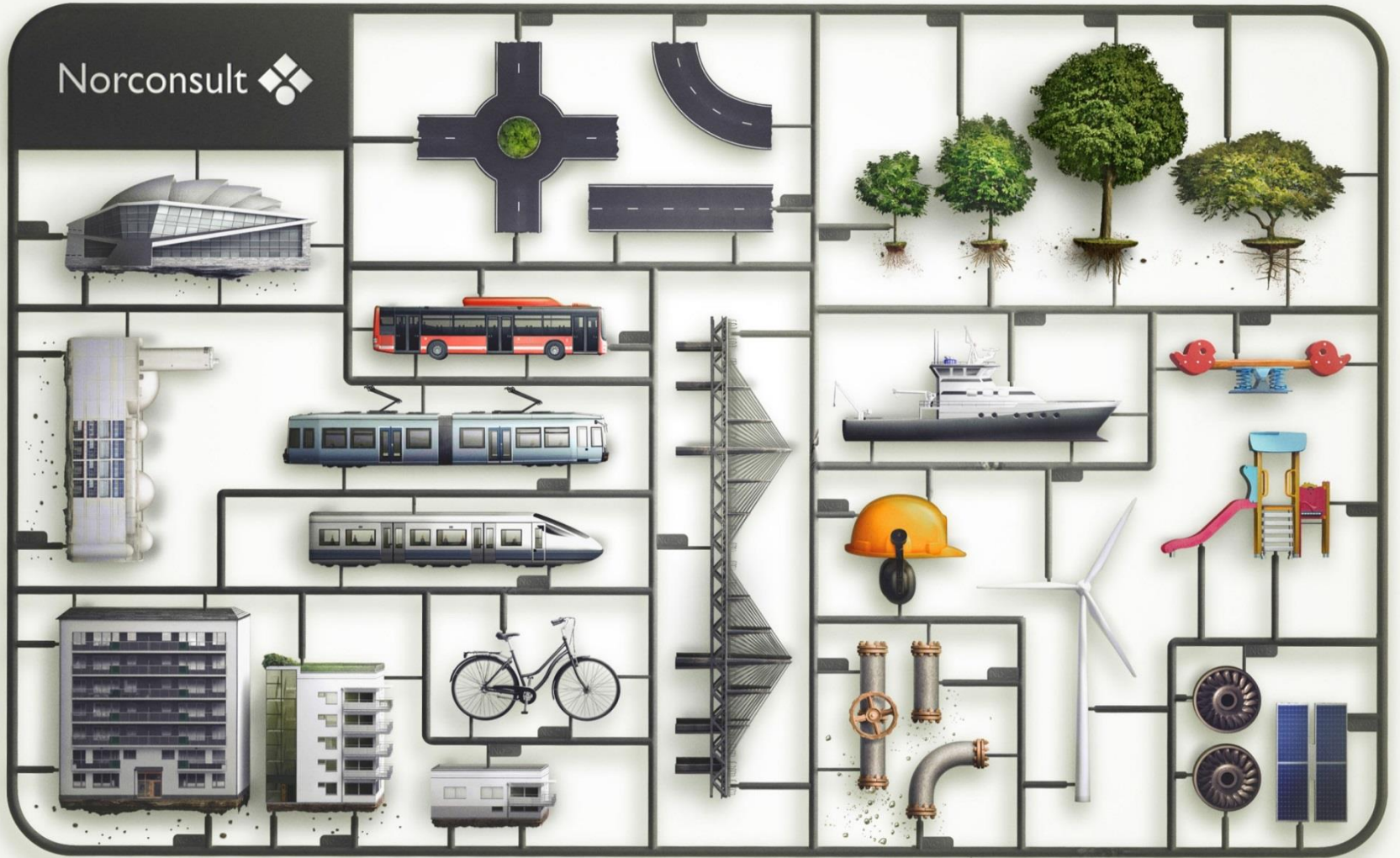

Thank you